

# Wellis®

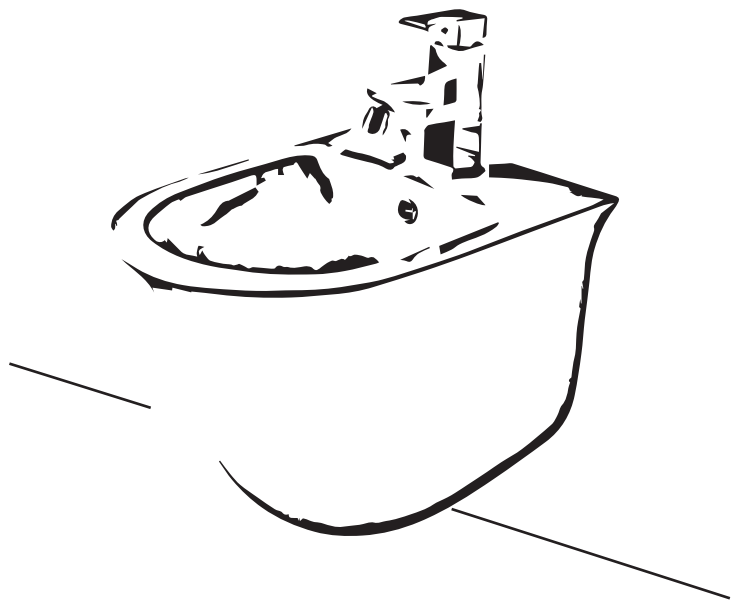

EN

**Olivia wall-mounted bidet**  
INSTALLATION MANUAL

DE

**Olivia wall-mounted bidet**  
INSTALLATIONSANLEITUNG

FR

**Oliviât bidet mural**  
INSTALLATION MANUELLE

HU

**Olivia falra rögzített bidé**  
ÖSSZESZERELÉSI ÚTMUTATÓ

RO

**Bideu de perete Olivia**  
INSTRUCȚIUNI DE MONTARE

WF00095

**OLIVIA**

## Before Installation

- 1 Make sure the wall should be straight.
- 2 Read the instruction to be familiar with the tools, fittings and installation procedures to prevent any unnecessary damage.
- 3 Check the fittings follow the fitting form and check whether there is any damage of the product.
- 4 Because the ceramic is easy to be damaged, please handle it gently and the nut should not be over-tightened.
- 5 Make sure water supply has been turn off.

## Tools (not included)



Flat Screwdriver



Drilling machine



Silica gel



Spanner



Spirit level



Tape measure



Pencil

## Installation Procedure

- 1 Put the bidet onto the suitable position, and make the water outlet of bidet aligned with the drainage outlet.

Note : Preposition enough distance for connecting water supply pipe and drain pipe.

- 2 Mark the installing holes on the floor.
- 3 Remove the bidet carefully and drill holes according to the mark. Insert the expansible plastics or install 7# fixing plastic.
- 4 Install faucet ,water supply valve and drain units according to the installation instruction for fittings.
- 5 Put the bidet onto the suitable position, and get the water supply valve and the faucet connected with soft pipe. Then adjust the connecting bar.

Note : Water faucet is not supplied with this product.

- 6 Get the screw aligned with the plastic particle and fix the bidet onto the floor. Then cover the decoration cap.
- 7 Daub a layer of silicone between the bidet and the floor.
- 8 Finish the installation.

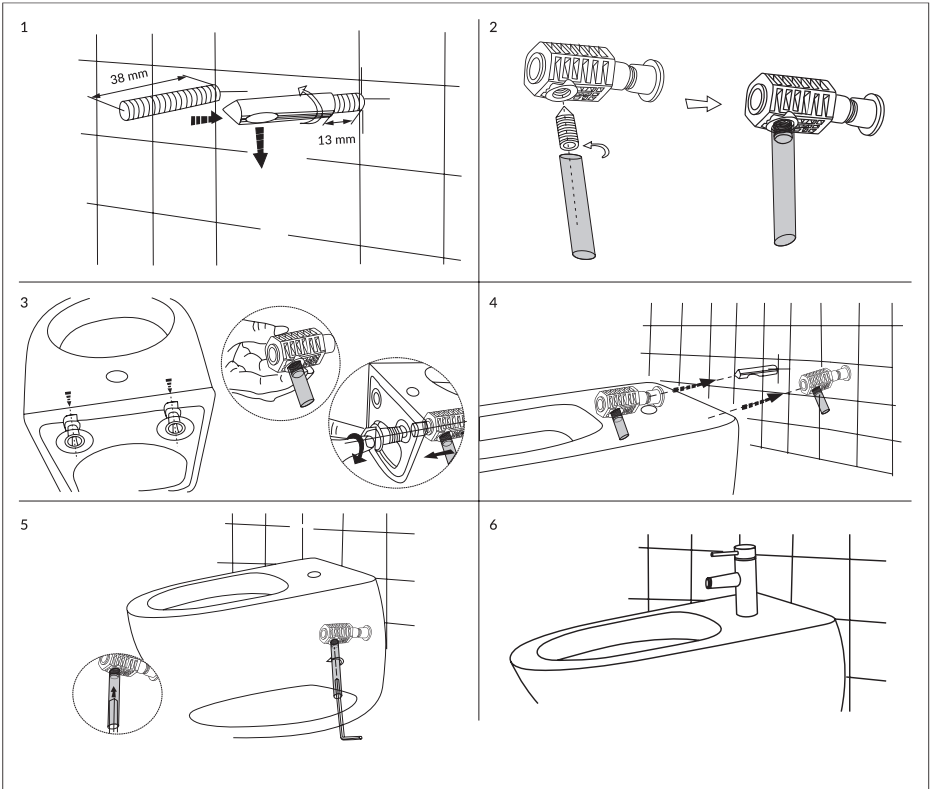
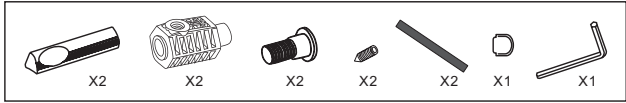

## Vor der Installation

- 1 Stellen Sie sicher, dass die Wand gerade ist.
- 2 Lesen Sie die Anleitung, um sich mit den Werkzeugen, Armaturen und Installationsverfahren vertraut zu machen, um unnötige Schäden zu vermeiden.
- 3 Prüfen Sie, ob die Verschraubungen der Verschraubungsform entsprechen und ob das Produkt beschädigt ist.
- 4 Da die Keramik leicht beschädigt werden kann, behandeln Sie sie bitte vorsichtig und die Mutter sollte nicht zu fest angezogen werden.
- 5 Stellen Sie sicher, dass die Wasserversorgung ausgeschaltet ist.

## Werkzeuge (nicht enthalten)



Flacher Schraubendreher



Bohrmaschine



Silicagel



Schlüssel



Wasserwaage



Maßband



Bleistift

## Installationsverfahren

- 1 Bringen Sie das Bidet in die geeignete Position und richten Sie den Wasserauslass des Bidet mit dem Abfluss aus.

Hinweis : Stellen Sie genügend Abstand für den Anschluss der Wasserversorgungsleitung und der Ablaufleitung vor.

- 2 Markieren Sie die Installationslöcher am Boden.
- 3 Entfernen Sie das Bidet vorsichtig und bohren Sie die Löcher entsprechend der Markierung. Legen Sie den Spreizkunststoff ein oder installieren Sie den 7#-Befestigungskunststoff.
- 4 Montieren Sie den Wasserhahn, das Wasserversorgungsventil und die Ablaufeinheiten gemäß der Installationsanleitung für die Armaturen.
- 5 Bringen Sie das Bidet in die geeignete Position und bringen Sie das Wasserzufuhrventil und den Wasserhahn mit einem weichen Rohr in Verbindung. Stellen Sie dann die Verbindungsstange ein.

Hinweis : Wasserhahn wird nicht mit diesem Produkt geliefert.

- 6 Bringen Sie die Schraube auf die Kunststoffartikel und befestigen Sie das Bidet auf dem Boden. Bedecken Sie dann die Dekorationsskappe.
- 7 Tragen Sie zwischen Bidet und Boden eine Silikonschicht auf.
- 8 Beenden Sie die Installation.

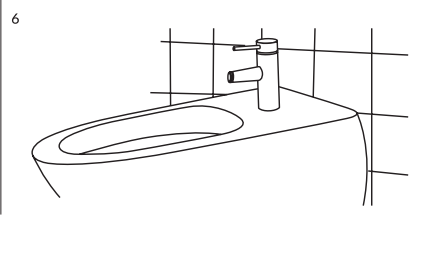
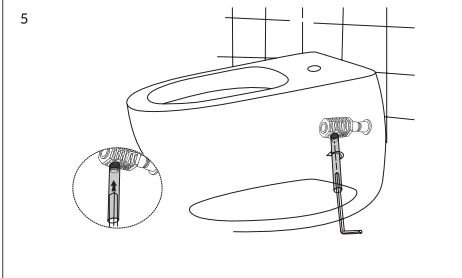
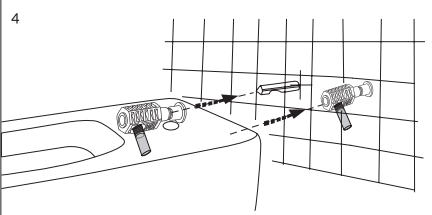
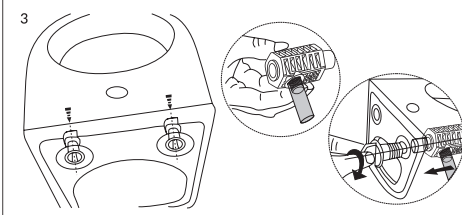
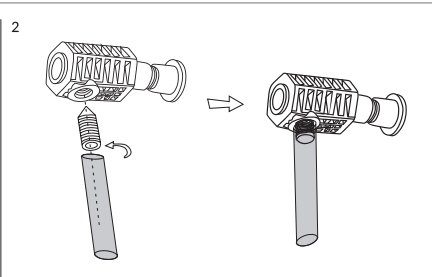
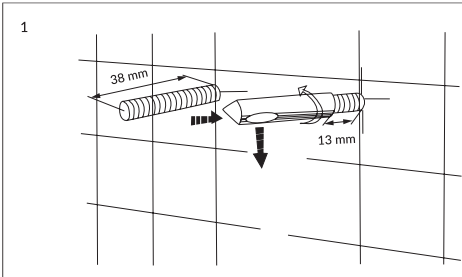
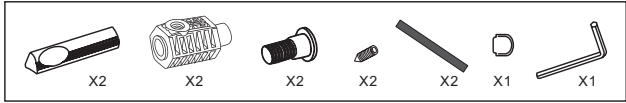

## Avant l'installation

- 1 Assurez-vous que le mur soit droit.
- 2 Lisez les instructions pour vous familiariser avec les outils, et les procédures d'installation et de raccords pour éviter tout dommage inutile.
- 3 Vérifiez que le raccord suive le formulaire de raccordement et vérifiez que votre produit ne soit pas endommagé.
- 4 Étant en céramique et facilement abîmable, manipulez-le avec douceur et l'écrou ne doit pas être trop serré.
- 5 Assurez-vous que l'arrivée d'eau est été fermée.

## Outils (non inclus)



Tournevis plat



Perceuse



Gel de silicone



Clé



Niveau à bulle



Mètre ruban



Crayon

## Procédure d'installation

- 1 Placez le bidet dans une position qui vous convient et alignez la prise d'eau du bidet avec la sortie de drainage.  
Remarque: Prévoyez assez de distance pour pouvoir connecter le tuyau d'arrivée d'eau et le tuyau de drainage.

- 2 Marquez les trous d'installation au sol.
- 3 Enlevez le bidet délicatement et percez les trous correspondants aux marques. Insérez le plastique extensible ou installez 7# le plastique fixant.
- 4 Installez le robinet, la valve d'arrivée d'eau et l'unité de drainage en respectant les instructions d'installation pour le raccordement.
- 5 Mettez le bidet dans une position qui vous convient et connectez la valve d'arrivée d'eau et le robinet avec le tuyau souple. Ajustez ensuite la barre de liaison.

Remarque: Le robinet d'eau n'est pas fourni avec ce produit.

- 6 Aligned la vis avec le morceau de plastique et fixez le bidet au sol. Couvrez-la ensuite avec le couvre-vis.
- 7 Enduisez d'une couche de silicone entre le bidet et le sol.
- 8 Finissez l'installation.

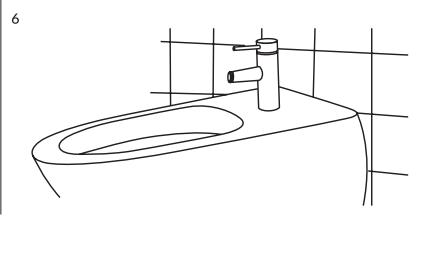
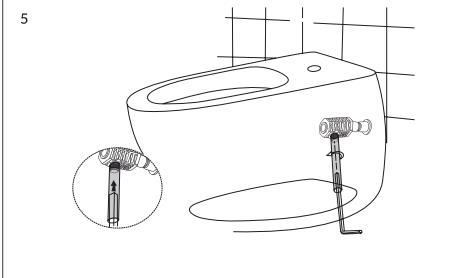
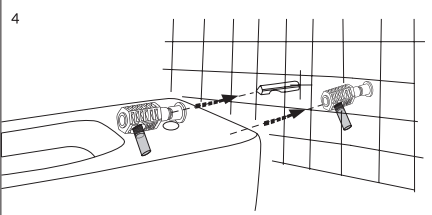
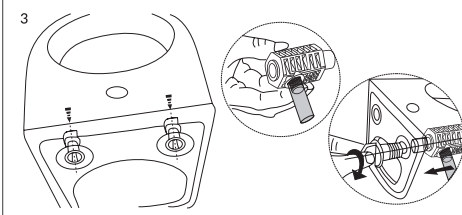
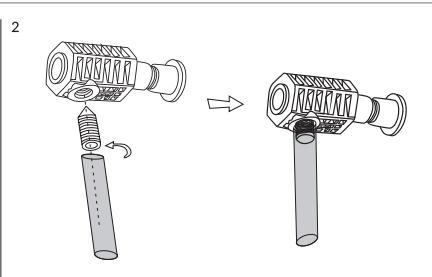
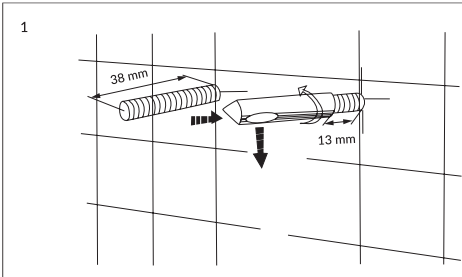
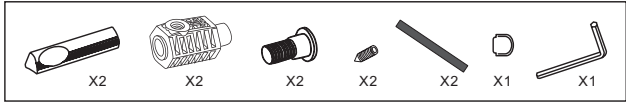

## Összeszerelés előtt

- 1 Győződjön meg arról, hogy a fal egyenes.
- 2 Olvassa el az útmutatót, hogy megismerje a szükséges szerszámokat, szerelvényeket és az összeszerelési folyamatot a nemkívánt káresek megelőzése érdekében.
- 3 Ellenőrizze, hogy a szerelvények megfelelően illeszkednek-e egymásba, és hogy nem sérült-e meg a termék.
- 4 Mivel a kerámia nagyon sérülékeny, kérjük, bánjon vele óvatosan, és ne húzza túl szorosra az anyákat.
- 5 Győződjön meg róla, hogy a vízvezeték el van zárva.

## Szerszámok (a doboz nem tartalmazza ezeket)



Lapos csavarhúzó



Fúrógép



Szilikongél



Csavarkulcs



Vízszintező



Mérőszalag



Ceruza

## Összeszerelés menete

- 1 Helyezze a bidét a kívánt helyre úgy, hogy a vízvezetető nyílása illeszkedjen a szennyvízelvezető kimenettel.

Megjegyzés: Hagyjon elég helyet mind a víz-, mind a szennyvízelvezetőknek.

- 2 Jelölje meg a furatok helyét a padlón.
- 3 Húzza el a bidét, és fúrja meg a lyukakat a jelölések helyén. Helyezze fel a túgulékony műanyagot, vagy szerelje be a 7# rögzítő műanyagot.
- 4 Szerelje fel a csaptelepet, a vízvezetékszelepet és a szennyvízelvezető egységeket az útmutató szerint.
- 5 Helyezze vissza a bidét a helyére, és a rugalmas vezetékkel kösse össze a vízvezetékszelepet illetve a csaptelepet. Majd állítsa be az összekötő szint.

Megjegyzés: A csaptelep nem tartozéka a terméknek.

- 6 Illessze a csavart a műanyagdarabhoz, és rögzítse a bidét a padlóhoz. Majd helyezze fel a díszkupakot.
- 7 Vigyen fel egy réteg szilikont a bidé és a padló közé.
- 8 Ezzel befejeződik a szerelés.



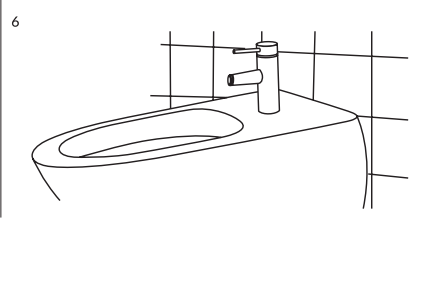
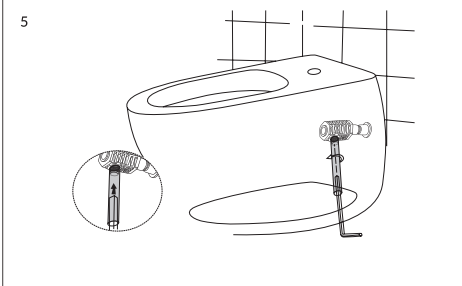
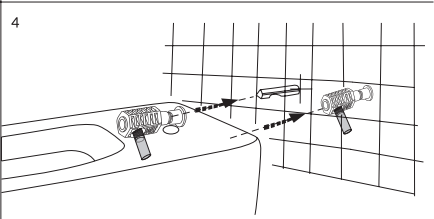
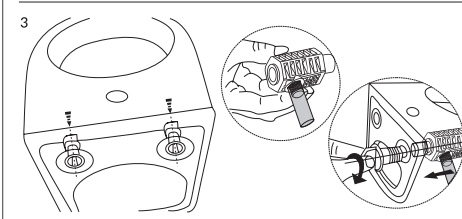
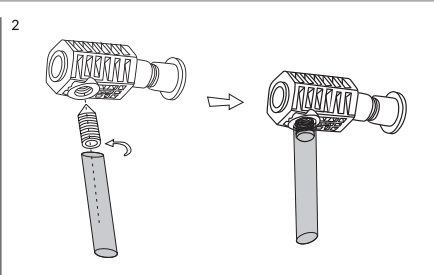
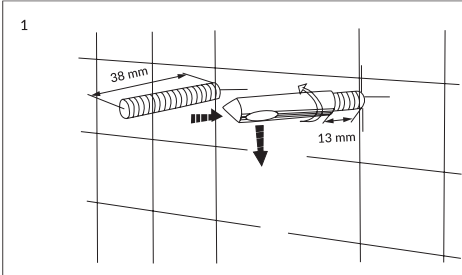
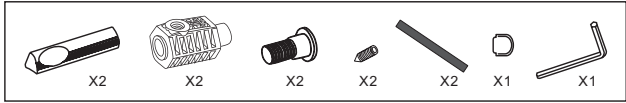

## Înainte de montare

- 1 Asigurați-vă că peretele este drept.
- 2 Citiți instrucțiunile pentru a avea cunoștință de sculele, instalațiile și procedurile de montare de care aveți nevoie pentru prevenirea eventualelor daune.
- 3 Verificați ca piesele să se potrivească bine una în cealaltă și dacă produsul s-a deteriorat.
- 4 Deoarece ceramica este fragilă, manipulați cu grijă și nu strângeți prea tare piulițele.
- 5 Asigurați-vă că alimentarea cu apă este oprită.

## Scule (neincluse în pachet)



Șurubelniță plată



Bormașină



Gel siliconic



Cheie



Nivelă cu bule



Ruletă



Creion

## Procedura de montare

- 1 Așezați bideul în locul dorit, astfel încât orificiul scurgerii să se potrivească la ieșire.  
Notă: Lăsați loc suficient pentru conductele de apă și evacuare.
- 2 Marcați locul găurilor pe podea.
- 3 Trageți la o parte bideul și realizați găurile în locul marcajelor. Așezați piesa de plastic flexibilă sau montați piesa de plastic de fixare 7#.
- 4 Montați bateria, ventilul de conductă și unitățile de evacuare conform instrucțiunilor.
- 5 Puneți la loc bideul și conectați cu un furtun flexibil ventilul de apă și bateria.  
Apoi reglați șinele de legătură.  
Notă: Bateria nu este accesoriul produsului.
- 6 Ajustați șurubul la piesa din plastic și fixați bideul de podea. Apoi, montați capacul decorativ.
- 7 Aplicați un strat de silicon între bideu și podea.
- 8 Montarea s-a finalizat.

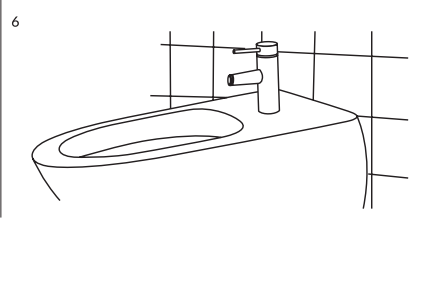
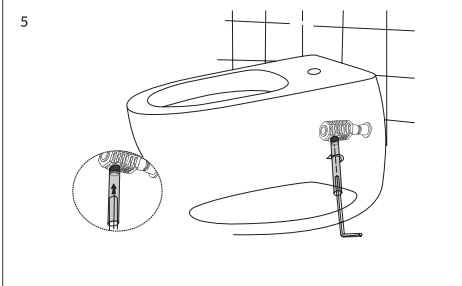
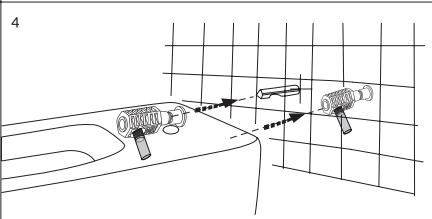
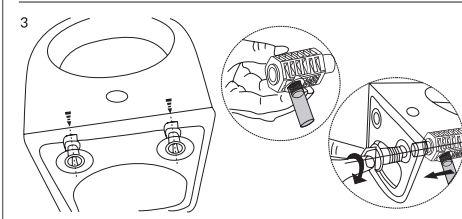
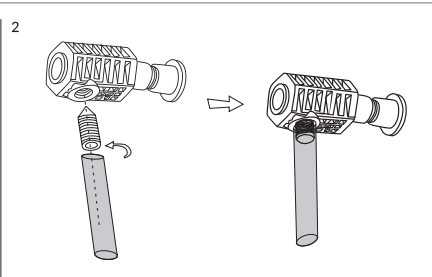
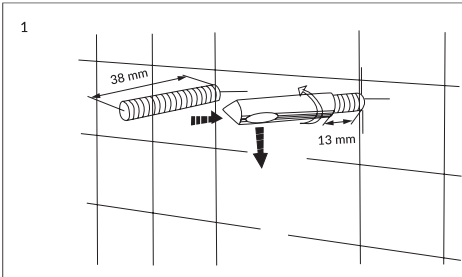
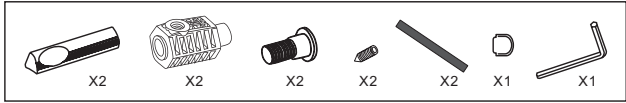

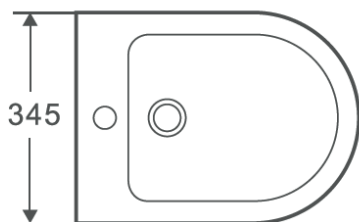
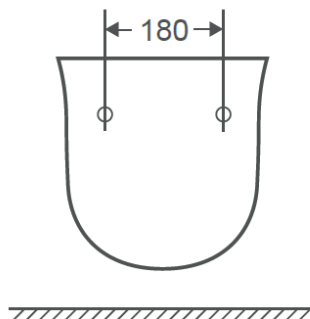
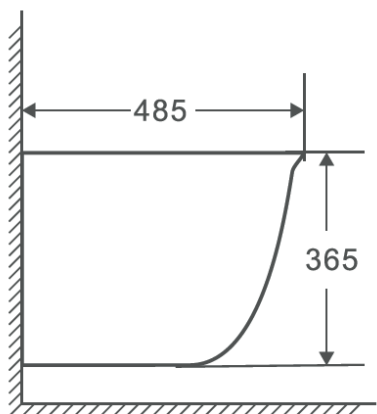







Wellis®

CE