



**SERIES VRG130**



Mtrl.nr. 9814 02 69 • Ritn.nr. 7045 utg. E • Rev. 1605



Series VRG131  
Series VRG132  
Series VRG133  
Series VRG138  
Series VRG139

PED 2014/68/EU, article 4.3

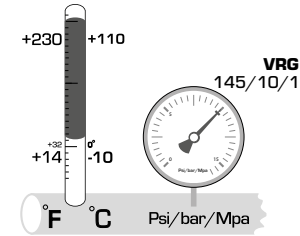
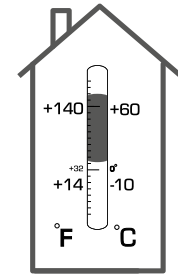

**1**

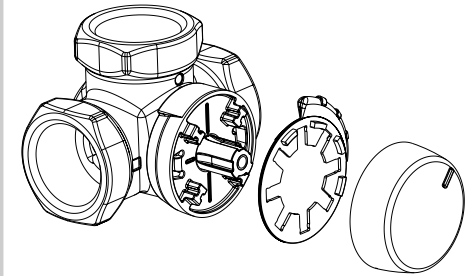

**i**

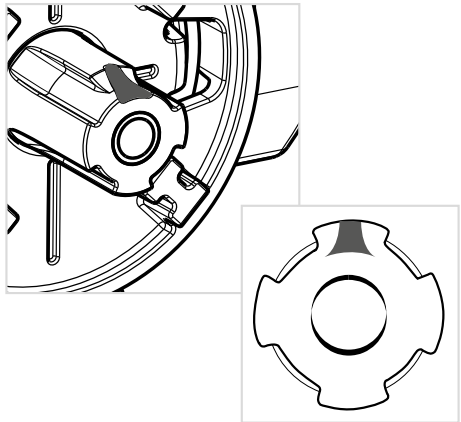

**i**

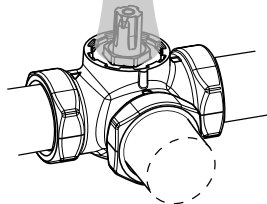
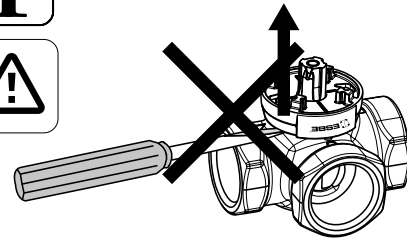

**2**

**a**

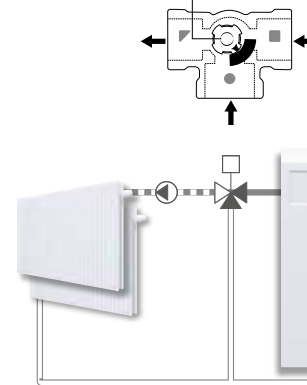
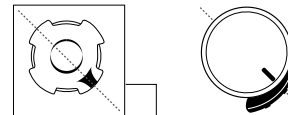

**b**

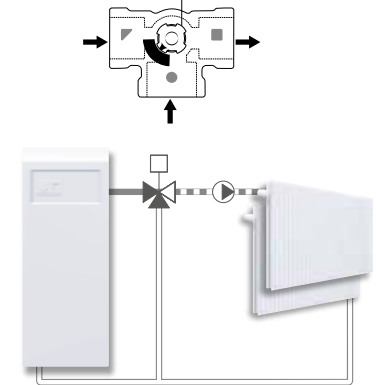
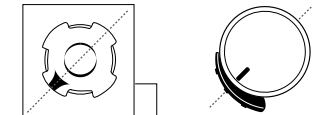

Piping Schematics are General Representations

**3**

**a**

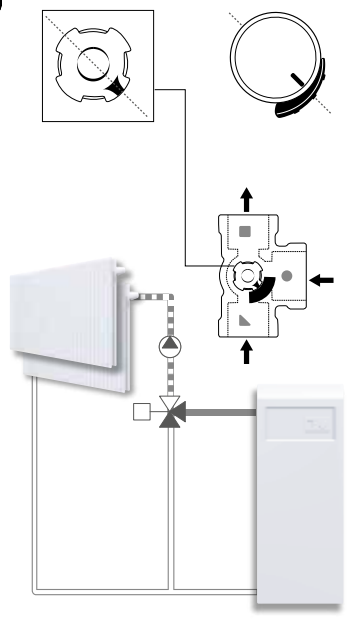

**b**

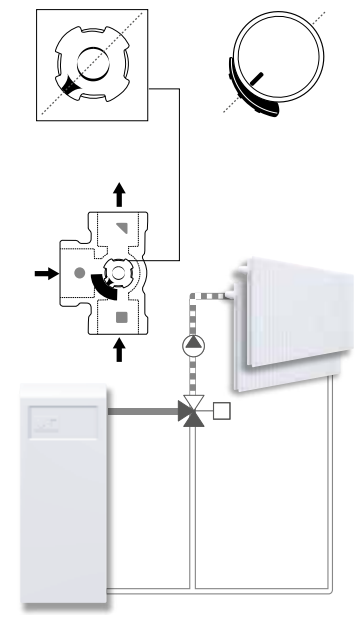

**4**

**a**

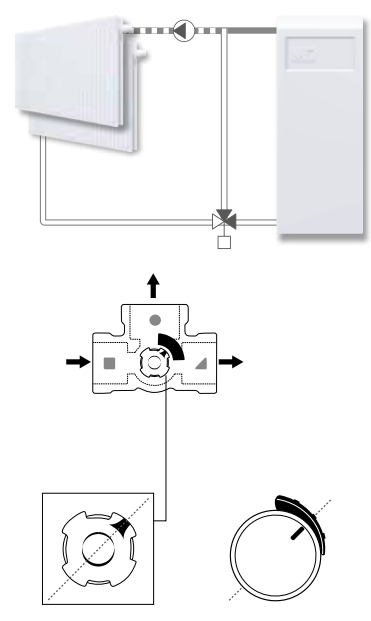

**b**

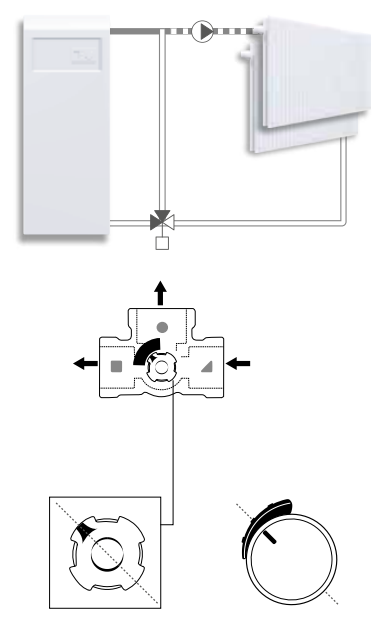

**i**



<http://www.esbe.eu/global/en/products/rotary-valves>